

Serial to Ethernet converter (Super Port)

(USR-K7)

File version: V1.0.0

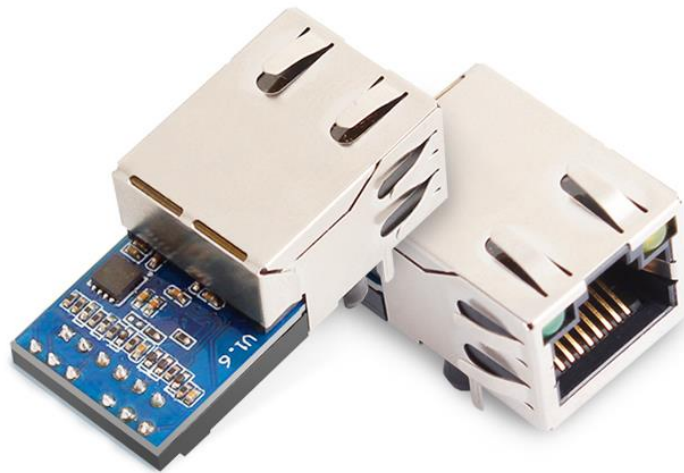

Contents

Serial to Ethernet converter (Super Port)	1
1. Introduction.....	3
1.1. Overview	3
1.2 Features.....	3
1.2. Basic parameters	4
1.3. Order information.....	5
1.4. Electrical characteristics	5
2. Module Test.....	5
2.1. Hardware connection	5
2.2. Login	7
2.3. Default parameter test	8
2.4. Data transmission text.....	9
3. Work mode.....	10
Diagram 3-2 work mode AT commend	11
3.1. UDP mode	11
3.2. TCP Client	12
3.3. UDP Server mode	13
3.4. TCP Server mode	15
3.5. Httpd Client mode	16
4. Hardware.....	18
4.1. Hardware.....	19
4.2. Pin definition	19
4.3. Size	21
4.4. Connection diagram	22
4.5. LED	22
4.6. RJ45 interface	22
5. Parameters configuration	23
5.1. Setup software configure parameters	23
6. Specific functions.....	28
6.1. Modbus RTU to Modbus TCP.....	28
6.2. Heartbeat package	30
6.3. Registration package.....	30
6.4. Web printing.....	31
6.5. Customize webpage.....	32
7. Contact us.....	33
8. Modified history	34

1. Introduction

1.1. Overview

Super port module USR-K7 is a new serial Ethernet module. It is a module that can realize data transmission between the network and TTL serial ports. This module is equipped with ARM cortex-m4 processor, which has the advantages of low power consumption, fast speed and high stability.

In terms of volume, the width of the device is equal to the common RJ45 port, and the length is less than twice the length of the common network port, with the industry-leading ultra-small volume, and the current is only 130mA when working at full speed.

This product is developed on the basis of the hardware and software of serial to ethernet M4 series. The internal integration of TCP/IP protocol stack, users can use it to complete the embedded device networking function easily, saving the development process of human, material and development cycle, so that products can be faster into the market, enhance competitiveness.

This product has been tested rigorously and has been successfully used in Banks, highways, large corporate networks, busy webcam networks and complex network environments such as fiber-optic to Ethernet.

1.2 Features

1. New Cortex-M4 kernel, industrial working temperature range(-40~85°C), elaborate optimization TCPIP protocol stack, stable and reliable.
2. Auto-MIDX function, discretionarily connect cross-over or direct network cable, automatic switching.
3. Support TCP Server, TCP Client, UDP, UDP Server, HTTPD Client, websocket, various of Ethernet protocols.
4. A built-in web page, also parameter setting via web, can customize web pages for users.
5. Reserve 485 enable pins.
6. Support RTS/CTS hardware flow control and Xon/Xoff software flow control
7. Support USR-VCOM
8. Serial port highest baud rate from 600bps to 1024Kbps, and support five calibration methods like None, Odd, Even, Mark, Space.
9. Support Modbus gateway, the industrial site is convenient to use.
10. Support Reload, hardware factory data reset
11. RJ45 status indicator light, RJ45 interface built-in isolation transformer, 1.5KV isolation.
12. Unique MAC address, and can customize MAC address.
13. Support upgrade firmware via network, support DNS and DHCP automatic access to IP.
14. Support keepalive, detect a dead link quickly and make connection more stable.
15. Support name and pass word, login page and set network more safety.
16. Support Websocket function, realize net and serial bi-transmission between net and serial.

1.2. Basic parameters

category	parameters	value
Hardware parameters	Work volt	DC 3.0~3.6 V, (the best is 3.3V)
	Work current	130mA@3.3V
	Net port specification	RJ45、10/100Mbps、adopted to both cross and direct connection
	Packaging form	Pin type packaging
	Serial port baud rate	600~1M (bps)
Software parameters	Network protocol	IP、TCP、UDP、DHCP、DNS、HTTP、ARP、ICMP、Web socket
	IP access way	Static IP、DHCP
	Domain name resolution	Support
	User configure	Software configure, webpage configure, AT commend configure
	Single transparent transmission	TCP Server/TCP Client/UDP Server/UDP Client
	Modbus	Modbus gateway: Modbus RTU to TCP, Modbus Polling
	Webpage to serial port	Web-Socket: web-page to serial port
	Httpd Client	Support
	Class RFC2217	Support
	Customize webpage	Support
	Web caching	Sent: 16Kbyte; Sent: 16Kbyte;
	Serial port caching	Sent: 2Kbyte; Sent: 2Kbyte;
	Average transmission delay	In LAN<10ms
	Software kit	Virtual.com, serial port, USR-Cloud, parameter configure
Others	Identification	CE、FCC、ROHS (Will be got in June)
	Level class	1.5KV EMC
	size	35.0x19.39x18.25 mm(L*W*H)
	Work tempt	-40~85c
	Store tempt	-40~105c
	Work humidity	5%~95% RH(no condensation)
	Store humidity	5%~95% RH(no condensation)

Diagram 1-1 Electrical parameters

1.3. Order information

Type	Part Numbers	Electric interface
Super Port	USR-K7	1*UART,1*RS232 built-in RJ45

Diagram 1-2 Order information

- Configuration method: serial port AT command/network AT command/webpage/Software
- Power supply: DC 3.3V only
- Inches: 33.02 x 19.01 x 19.15 (mm, include the Shrapnel)
- Work temperature: -40~+85°C
- Store temperature: -40~85°C, 5~95%RH
- Buffer of comm port: 2K byte
- Buffer of Network: 16K byte

1.4. Electrical characteristics

All the data is get at temperature 25C, network cable plug in, max data transmission (10ms, 20 byte, sending data constantly).

	Input Voltage range	Current consumption at 3.3V
USR-K7	DC3.3V	130mA

Diagram 1-3 Electrical information

2. Module Test

If you have any question, please contact us the in the client support center:

<http://h.usriot.com/index.php?c=frontTicket&m=sign>

2.1. Hardware connection

The picture below is a serial device server of USR-K7. It have 1 UART to Ethernet interface.

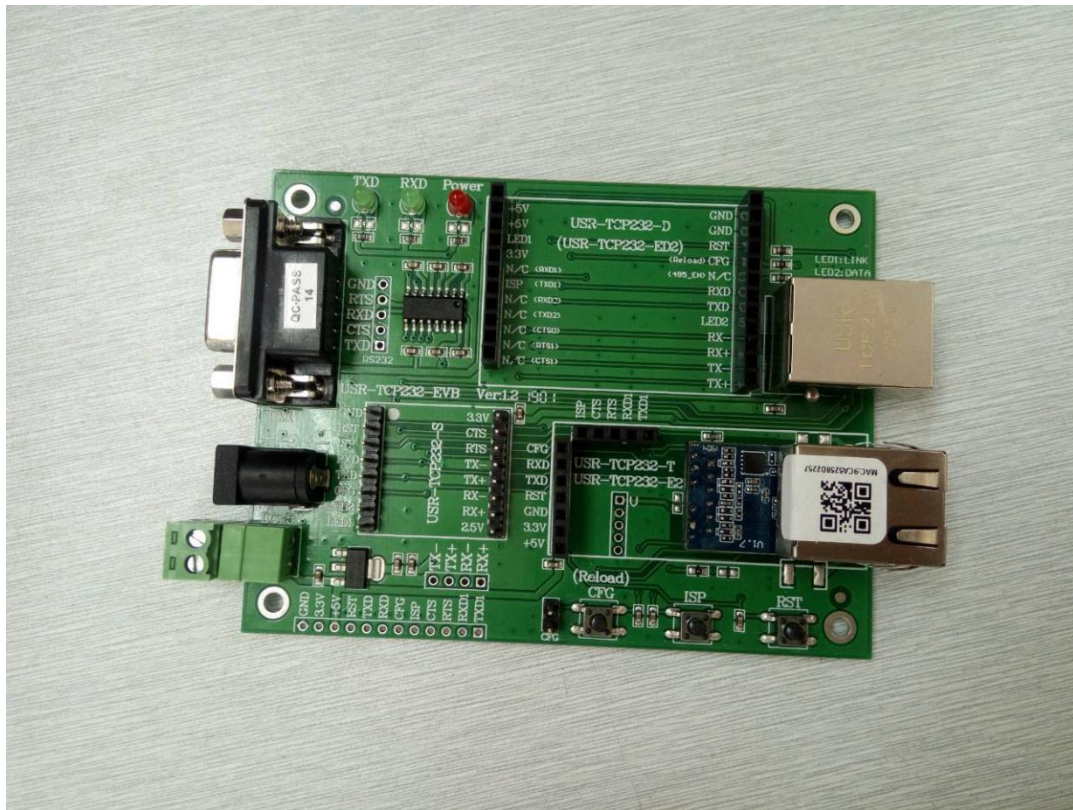

Diagram 2-1 Development Kit

Power the development kit board with DC5V adaptor(make sure you can supply at least 200mA current at DC5V, USR-K7 only accept DC3.3V, but since we are using a eval board, DC5V will do)

Connect K7's RJ45 to PC directly with network cable(No need to distinguish cross or direct connect cable), or connect the module and PC via switch or router and set the PC's ip address to 192.168.0.201 (must be a format of 192.168.0.xxx), net mask 255.255.255.0.

Connect development board's RS232 and PC's comm port together, with a standard male-female extend cable(default no-cross-over cable).

Here is USR-K7's default net configuration,

IP address: 192.168.0.7

Subnet mask: 255.255.255.0

The default gateway: 192.168.0.1

To test the transmission between serial and network, we put the k7 to evaluation board, and connect evaluation board and computer via serial port or USB, connect net port of K7 and PC, after the hardware connection is tested to be error-free, connect the power adapter we distributed to power the K7 evaluation board. The connection diagram is shown in the figure below:



Diagram 2-2 Hardware connection

2.2.Login

The default IP address of USR-K7 is 192.168.0.7. Open your web browser and enter this IP to connect to USR-K7 for configuration. Before that, please assign a static IP address of your PC in the same network segment as module's from 192.168.0.2 to 192.168.0.24 range.

User name and password is 'admin' .

User name and password are both "admin", this can be modified after login into the system.

Default user name: admin

Default password: admin

After you login, you can see webpage as follow,

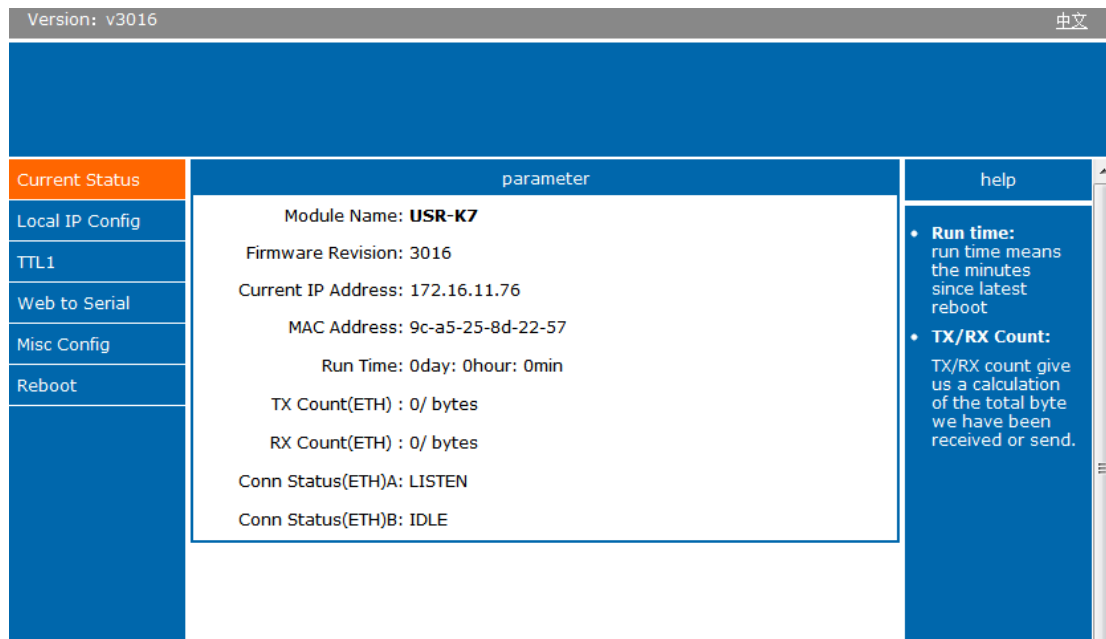

Diagram 2-3 webpage after login

- Current Status: the module's name, current IP, firmware revision, and other status information
- Local IP Config: the module's IP address, submask and gateway parameter
- TTL1: the module's serial to Ethernet parameter
- Web to Serial: web to serial data transparent
- Misc Config: some parameter such as user name and password parameter

- Reboot: user can reboot/restart module from here

Current Status	Parameter	Help
Local IP Config	Baud Rate: <input type="text" value="115200"/> bps(600~230400)bps	<ul style="list-style-type: none"> • Local Port 1~65535, when TCP Client, set this to 0 means use random local port • Remote Port 1~65535 • Packet time/length default 0/0, means automatic packet mechanism; you can modify it as a none-zero value
TTL1	Data Size: <input type="text" value="8"/> bit	
Web to Serial	Parity: <input type="text" value="None"/>	
Misc Config	Stop Bits: <input type="text" value="1"/> bit	
Reboot	Flow Mode: <input type="text" value="NONE"/>	
	UART Packet Time: <input type="text" value="0"/> (0~255)ms	
	UART Packet Length: <input type="text" value="0"/> (0~1460)chars	
	Sync Baudrate(RF2217 Similar): <input checked="" type="checkbox"/>	
	Enable Uart Heartbeat Packet: <input type="checkbox"/>	
	Socket A Parameters	
	Work Mode: <input type="text" value="TCP Server"/> <input type="text" value="None"/>	
	TCP Server MAX Sockets: <input type="text" value="8"/> Up to MAX <input type="text" value="KICK"/>	
	Local/Remote Port Number: <input type="text" value="23"/> <input type="text" value="23"/> (1~65535)	
	PRINT: <input type="checkbox"/>	
	ModbusTCP Poll: <input type="checkbox"/> Poll Timeout: <input type="text" value="200"/> (200~9999) ms	
	Enable Net Heartbeat Packet: <input type="checkbox"/>	
	Registry Type: <input type="text" value="None"/> Location <input type="text" value="Connect With"/>	
	Socket B Parameters	

Diagram 2-4 webpage -TTL1

2.3.Default parameter test

Use test program USR-TCP232-Test to make the testing of transmitting and receiving.

The left side is serial port, keep the same parameters as PC (Here is default settings).

The right side is the network side, protocol sets as TCP Client, server IP sets as 192.168.0.7, port 23.

By default, USR-K7 works as TCP Server ,port 23.

This illustration shows the 10 ms two-way simultaneous automatically transmit screen shots. As the allocated memory of the display control is limited, in order to test large amount of data transceiver, here will suspend the receive display, only statistical data. Below is the effect after testing for a few hours, and transmitting millions of bytes. Stable and reliable, without a byte loss.

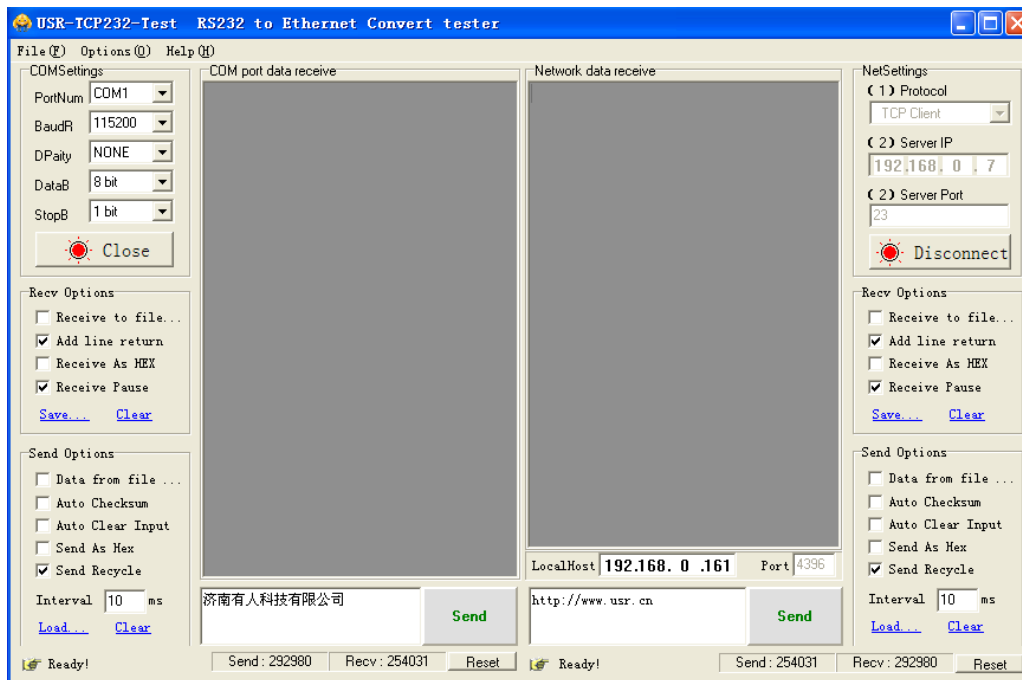

Diagram 2-5 default working mode communication

Chart 1 default parameters

project	content
User name	admin
Password	admin
IP address	192.168.0.7
K7 subnet mask	255.255.255.0
K7 default gateway	192.168.0.1
K7 port1 default mode	TCP Server
K7port1 default interface	23
Serial port baud rate	115200
Serial port parameters	None/8/1

Diagram 2-6 Default parameters

2.4. Data transmission text

After above steps, you can do bi-communication between serial port and Ethernet. Step are as follows:

- 1) Open the 'USR-TCP232-Test.exe', connect the hardware.
- 2) Choose the TCP Client mode in net setting, put in 192.168.0.7 in server IP address, and the port number is 23. Click connection to built TCP link. Serial port baud rate is 115200, serial port parameters is None/8/1, then click OPEN to open the serial port.

Now we can text the data transmit between serial port and network. The data flow from serial port to network is: computer serial port ->K7 serial port ->K7 Ethernet port -> computer network;

The data flow from network to serial port is: computer network ->K7 Ethernet port ->K7 serial port -> computer serial port.

Detail are as follows:



Diagram 2-7 Default parameters text

3. Work mode

There are 5 work modes for K7, including UDP Client、TCP Client、UDP Server、TCP Server、Httpd Client. You can configure it by webpage and setting software. Detail are as follows:

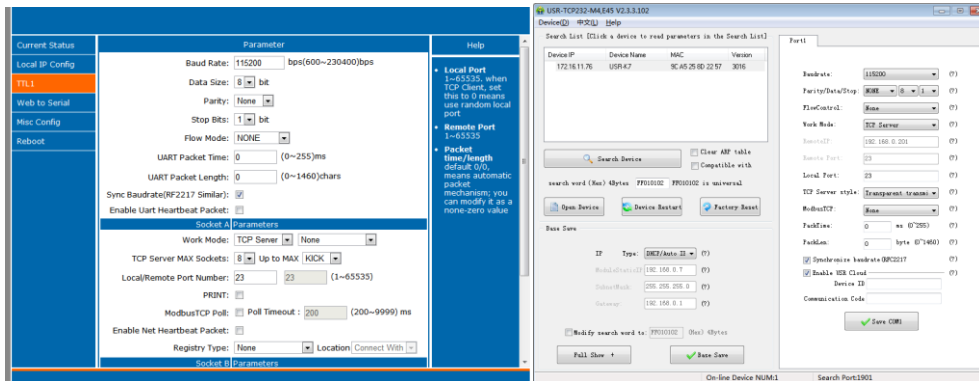

Diagram 3-1 Work mode setting example

Refer to AT commend:

Name	description
AT+SOCKA1	Set K7 SOCKA communication protocol /Destination IP/Destination port
AT+SOCKB1	Set K7 SOCKB communication protocol /Destination IP/Destination port

Diagram 3-2 work mode AT commend

3.1.UDP mode

In UDP mode, after power on, module listen on specific port.

When received data from this udp port, send it to serial port;otherwise, when data is received from serial port, send it to ethernet.

The assist software can be download from link below:

<http://www.usriot.com/Download/199.html>

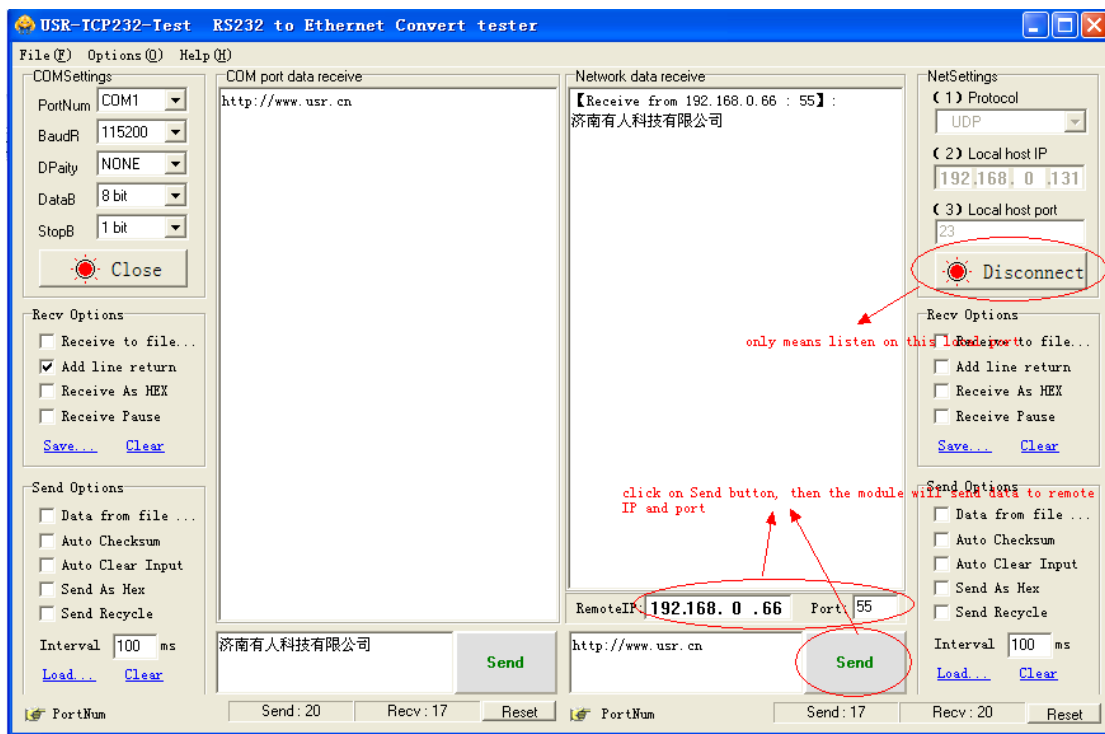

Diagram 3-4 UDP mode communication test

Note:

- 1) local port and remote port can be different.
- 2) Max UDP send length(ethernet to serial) is 1472 bytes. If you want to send more than 1472 Bytes, please div it into shorter packet.

3.2.TCP Client

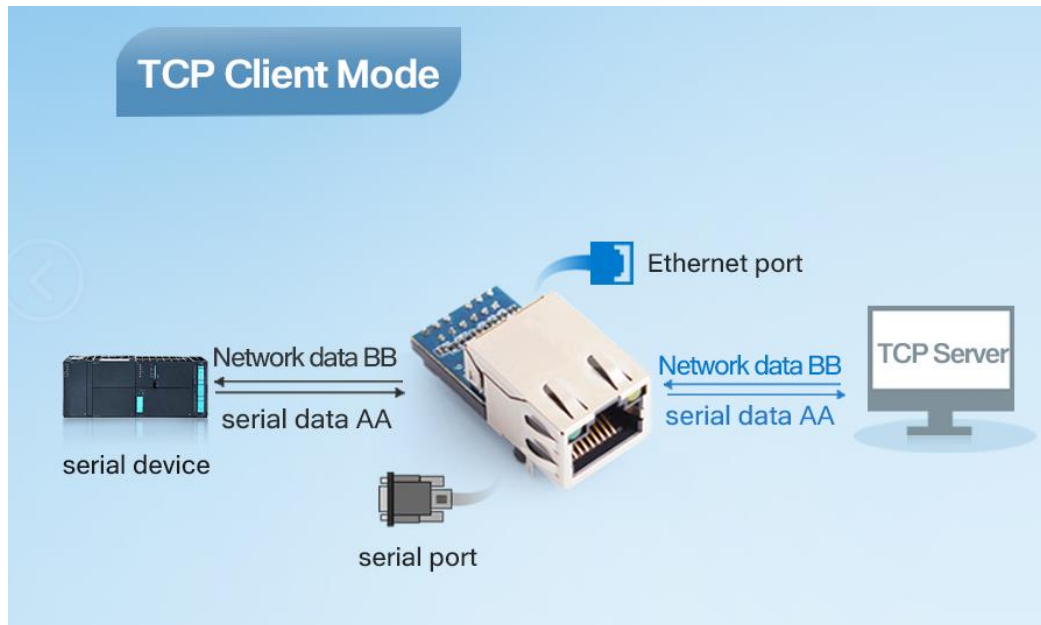

Diagram 3-5 TCP Client mode instructions

- 1) TCP Client provide Client connection to TCP network service. It can initiate a connection and connect to the server to realize the transmission between serial port data and server data. According to related provisions of TCP protocol,TCP client makes a distinction between connection and disconnection to ensure the exchanging of data. Usually, it is the most common form of network communication which adopted to data interaction between devices and servers.
- 2) This mode have a function that identify connection exceptions actively. After connected, there will be about 15s interval to sent KeepAlive. If there is an abnormal interruption of the connection, etc., it will be detected immediately and prompt K7 to break the original connection and reconnect
- 3) When K7 try to connect server as TCP Client, the local port is 0, each time a link is initiated on a random port.
- 4) This mode supports the synchronous baud rate function, transmission cloud and Modbus TCP function of USR.
- 5) In the same LAN, if K7 is set as static IP, please set the IP of K7 as gateway IP and correctly set the gateway IP address, otherwise normal communication will not be possible.
- 6) Note: KeepAlive function, sync baud rate function, pass-through cloud function, Modbus TCP function are described in detail below.

Use USR-TCP232-Test,

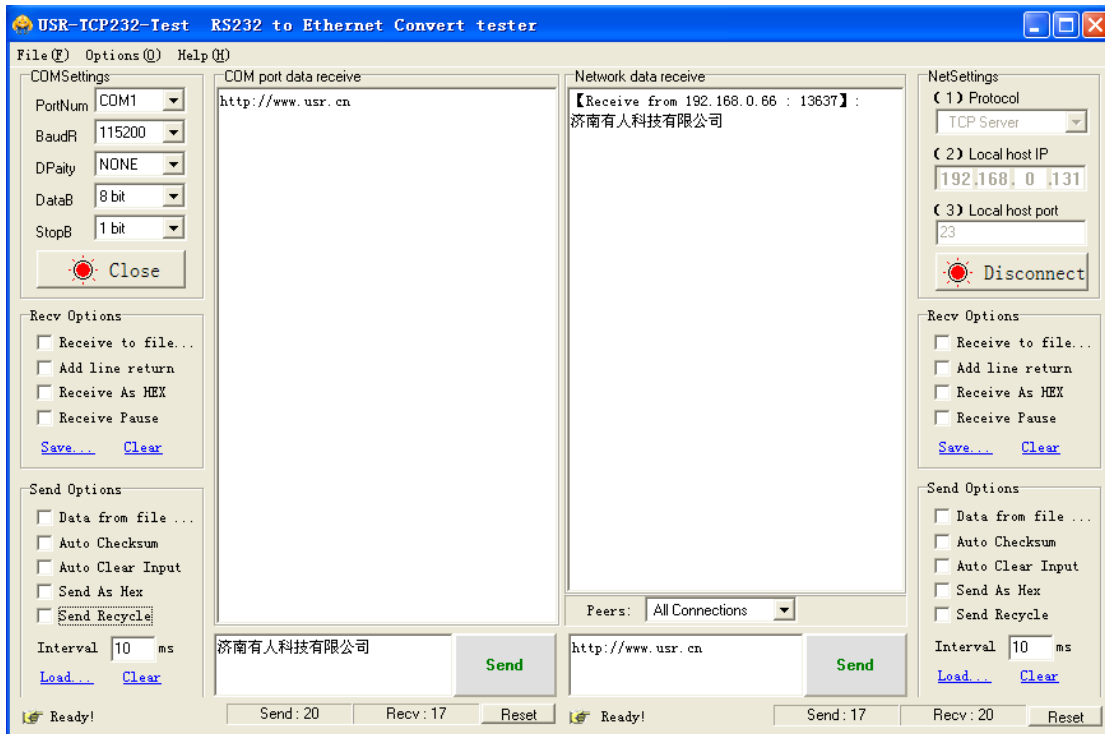
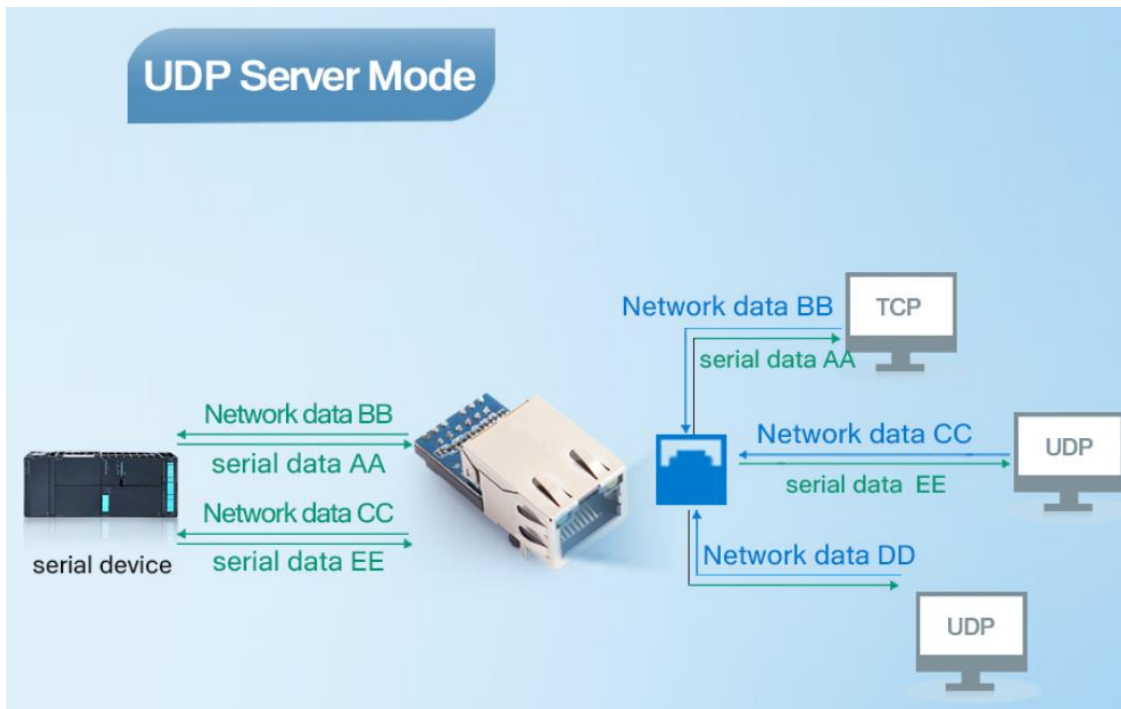

Diagram 3-6 TCP Client communication test

3.3.UDP Server mode



- 1) UDP Server does not verify the source IP address on the basis of ordinary UDP. After each UDP packet is received, the target IP is changed to the data source IP and port number. When sending data, it is sent to the latest communication IP and port number.
- 2) This pattern is usually used for data transmission scenarios where multiple network devices need to communicate with the module and do not want to use TCP due to the high speed and frequency.

Like the socket UDP server in PC API. Many to one data transfer supported, the data from UART part will be transformed to the last UDP packet's address.

Here show 2 UDP client communicate with server, server send data to the last client communicates with it.

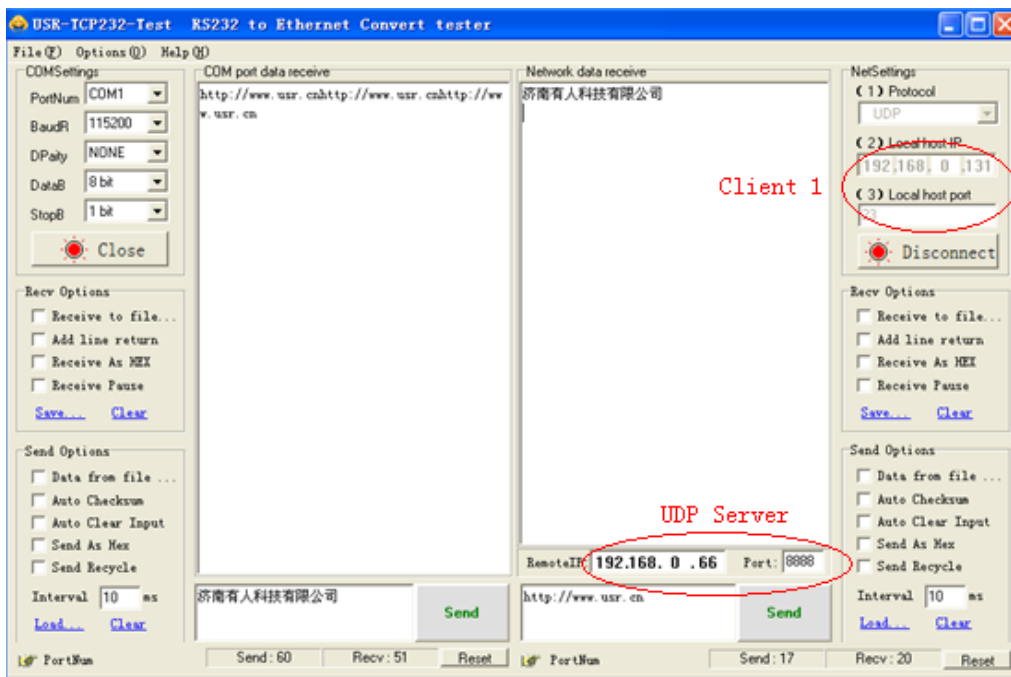

Diagram 3-8 Client 1 <-> server

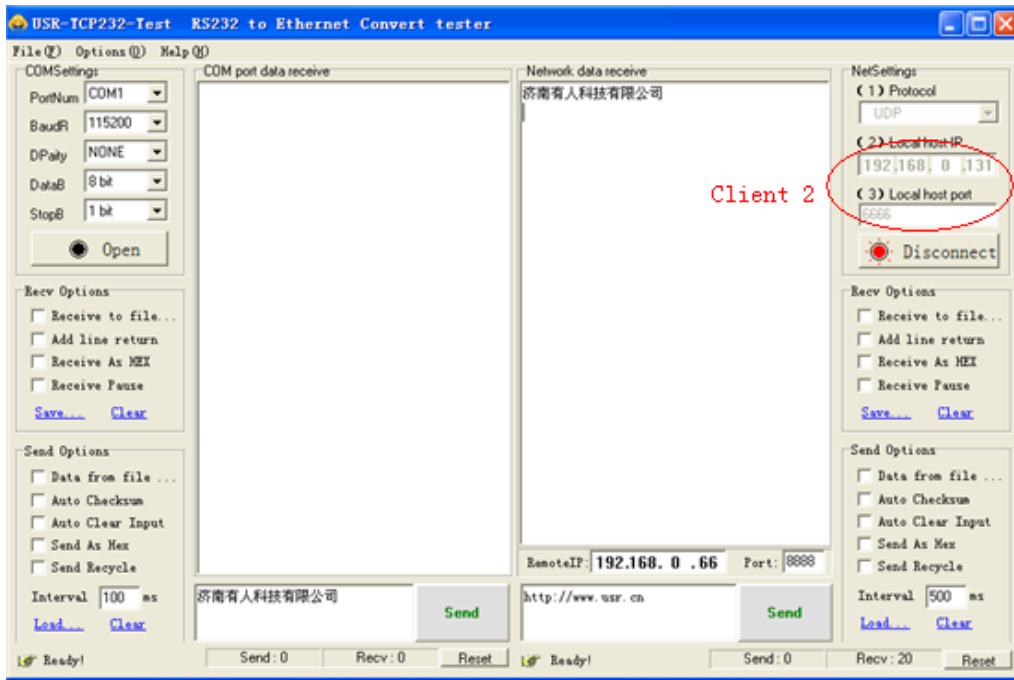
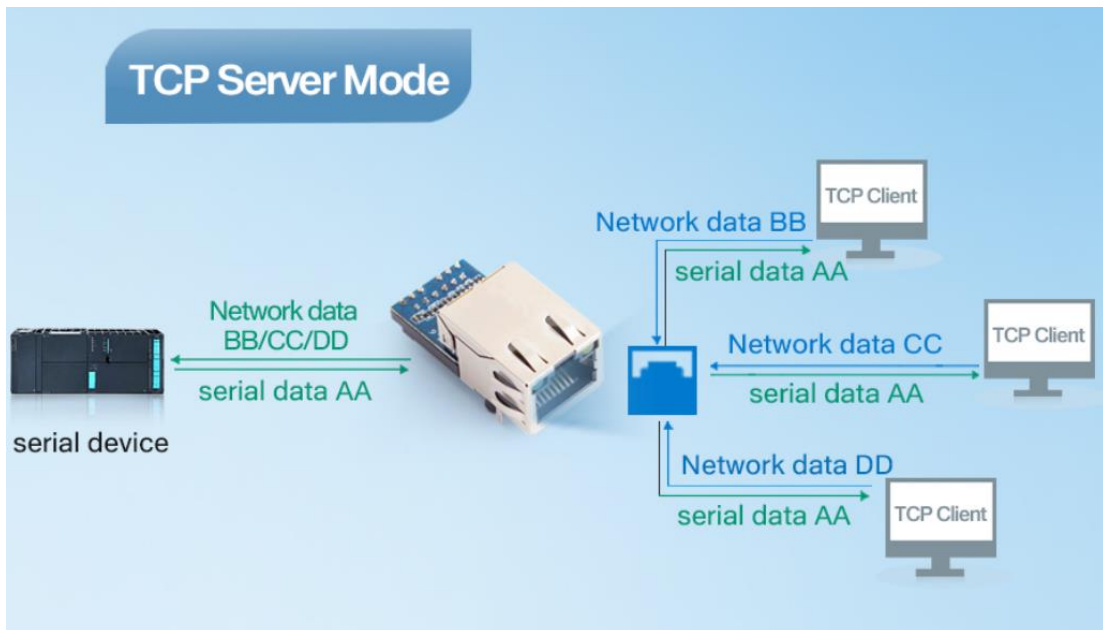

Diagram 3-9 Client 2 <-> server

3.4. TCP Server mode



1) In TCP server mode, module listens to the local port, accepts connection requests and established connection for data communication. When the module port receive the data, it will sent data to all the client devices connected to module. And then, TCP server mode also has KeepAlive function to monitor the integrity if connection.

- 2) Usually used for communication with TCP client in LAN, it is suitable for scenarios where there are no servers on the LAN and multiple computers or mobile phones are requesting data from the module. As the TCP client, there are distinctions between connection and disconnection to ensure the reliable exchange of data.
- 3) This mode supports synchronous baud rate (RFC2217) and Modbus TCP function of USR.
- 4) When K7 work as a TCP server, its max link number is 8.(later expanded to 32)

TCP Server mode have 2 parameters: max link number and link type

1. max link number: 1 ~ 8;

parameter

Baud Rate: bps

Data Size: bit

Parity:

Stop Bits: bit

Flow Control and RS485:

Local Port Number:

Remote Port Number:

Work Mode:

TCP Server detail: type

Remote Server Addr: [N/A]

Timeout: seconds (< 256, 0 for no timeout)

UART packet Time: ms (< 256)

UART packet length: chars (<= 1460, 0 for no use)

Sync Baudrate(RF2217 similar):

Diagram 3-11 Webpage configuration

3.5.Httpd Client mode

In this mode, user's terminal devices can sent question data to pointed HTTPD server, and then K7 accepts the data form HTTPD Server, analyze data and sent the results to serial port.

Users needn't pay attention to the data conversion process between the serial port and the network, and only needs simple parameters set to realize the data request from the serial port device to the HTTP Server.

If the data haven't pass the K7 and server haven't disconnect active, the module will automatically disconnect.

The detailed working diagram and setup example diagram of Httpd Client mode are as follows.



This function is easier used for web page developer. We establish one web server page, add this: `<?php echo $_GET['data']; ?>`

Means we can GET data from HTTP client's request. Open this URL: `test.usr.cn/1.php?data=12345`, the web page is downbelow, we can see that the web server have got the data(12345),

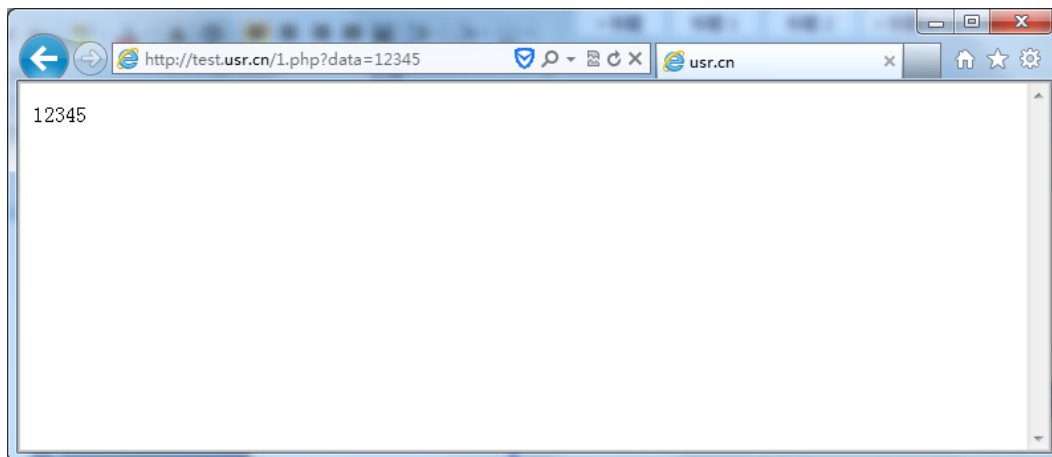

Diagram 3-13 Request `test.usr.cn/1.php?` and upload data

Then we take another way, set USR-K7 module Work mode HTTPD Client, Target address `test.usr.cn`, remote port 80.

Baud Rate:	<input type="text" value="115200"/>	bps(600~1024000)
Data Size:	<input type="text" value="8"/> ▼	bit
Parity:	<input type="text" value="None"/> ▼	
Stop Bits:	<input type="text" value="1"/> ▼	bit
Flow Control and RS485:	<input type="text" value="RS485"/> ▼	
Local Port Number:	<input type="text" value="23"/>	
Remote Port Number:	<input type="text" value="80"/>	
Work Mode:	<input type="text" value="Httpd Client"/> ▼	<input type="text" value="None"/> ▼
HTTPD Client header(<180byte):	<pre>GET /1.php?data=\$ HTTP/1.1 Host: test.usr.cn</pre>	
Remote Server Addr:	<input type="text" value="test.usr.cn"/>	
Timeout:	<input type="text" value="0"/>	seconds (< 256, 0 for no timeout)
UART packet Time:	<input type="text" value="0"/>	ms (< 256)
UART packet length:	<input type="text" value="0"/>	chars (<= 1460, 0 for no use)
Sync Baudrate(RF2217 similar):	<input checked="" type="checkbox"/>	
Enable USR Cloud :	<input type="checkbox"/>	
Device ID:	<input type="text"/>	
Communications Code :	<input type="text"/>	

Diagram 3-14 configure HTTPD Client

Open USR-TCP232-Test, and type in a string such as "12345", then send via comm port to USR-K7, and see the response from test.usr.cn .

In the response, all the data returned, but the http header from server will be returned, too. the user may need to parse this to get your data.

4. Hardware

About the new PCB libraries file, we can download it from website <http://www.usriot.com/Download/221.html> .

4.1. Hardware

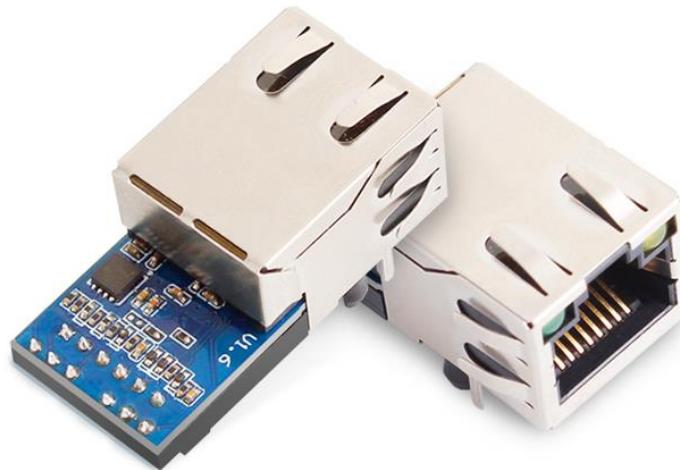

Diagram 4-1 USR-K7

- Mechanical dimension: 33.02 x 19.01 x 19.15 (mm, include the Shrapnel)
- 3.3V power input
- 1 * UART (TTL, 3.3V)
- support hardware flow control(RTS/CTS)

4.2. Pin definition

USR-K7 module has 16 external pins: two of which are fixed pins and two of which are metal shell pins. About the unused pins marks as NC which can be hanged in the application.

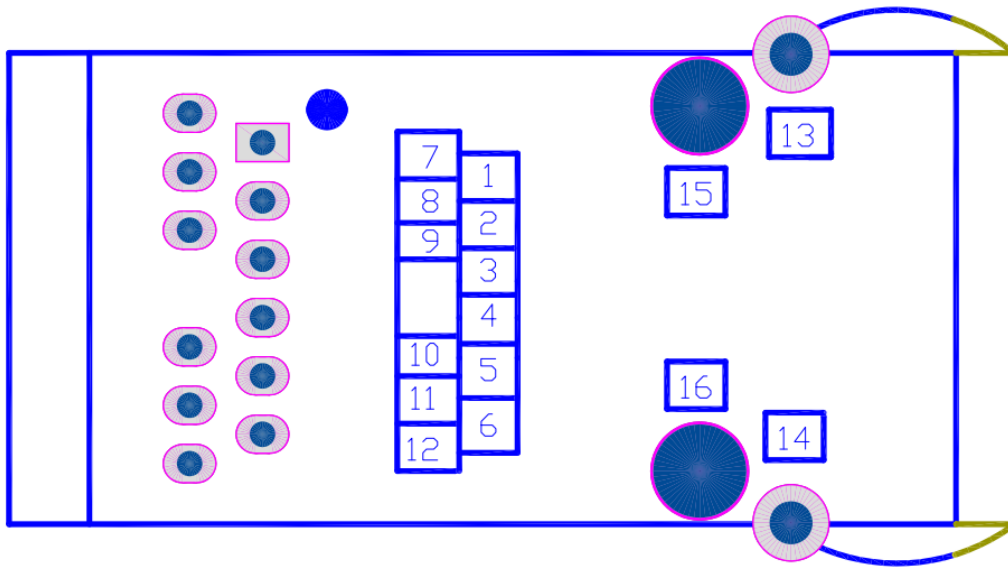

Diagram 4-2 pin diagram of K7(left for top view, right for bottom view)

PIN	NAME	Definition
1	NC	Not available
2	NC	Not available
3	CTS	Can be used as hardware flow control CTS pin (Clear to send). Default not available.
4	RST	reset the module (Inputting low level over 200ms to reset the module)
5	RTS	Can be used as hardware flow control RTS pin (request to send). Default is RS485 receive/send controlling pin, high level to send.
6	Reload	Module can restore the factory settings, in the case of module power off (or reset), pull down Reload, then power on, keep Reload 5S pull down, after more than 5S pull up, restore the factory settings successfully.
7	NC	Not available
8	RXD	Serial port receiving pin(3.3V, TTL level)
9	TXD	Serial port receiving pin(3.3V, TTL level)
10	GND	Ground (including power ground and power ground)
11	VDD	Power (external demand for pin DC 3.3V power supply)
12	NC	Not available
13	ETH	Mesh port shielding shell pin
14	ETH	Mesh port shielding shell pin
15	Fixed column	Modular Fixed Column
16	Fixed column	Modular Fixed Column

Diagram 4-3 Pin definition

4.3. Size

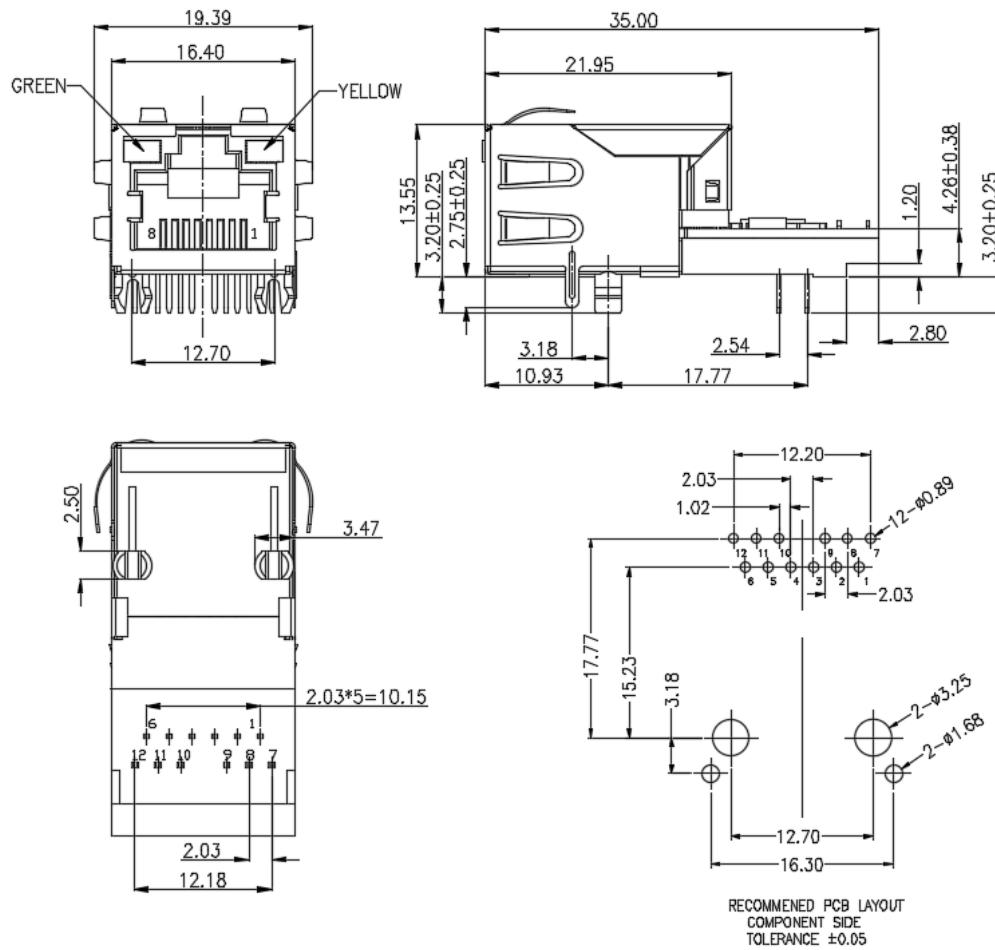

Diagram 4-4 inches

4.4.Connection diagram

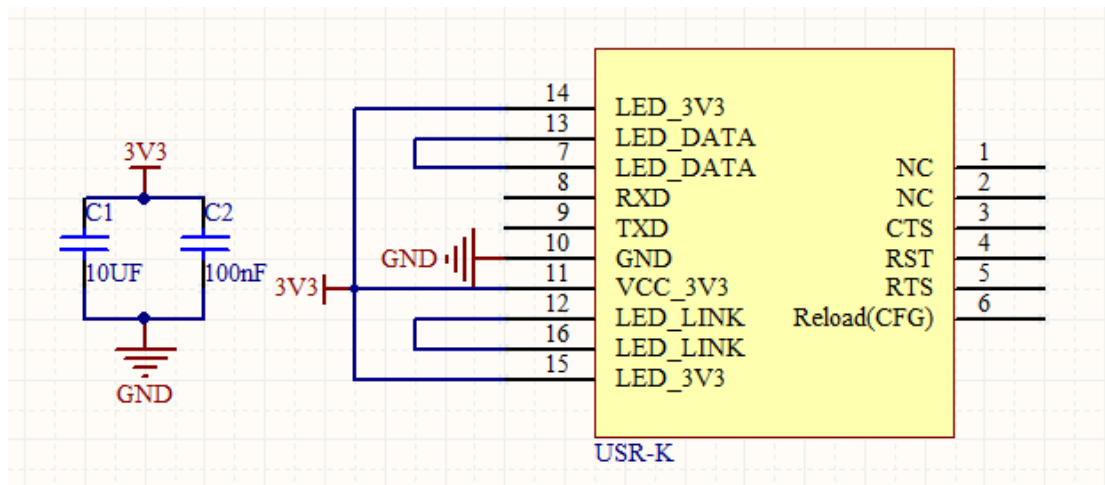

Diagram 4-5 connection diagram

This is connection diagram for USR-K7 when user design their product with K3, there is a few points we need to attend to

- Power K7 with a stable 3.3V
- Connect 2 LED_3V3 together
- Connect 2 LED_DATA together
- Connect 2 LED_LINK together
- Connect RXD, TXD with user's MCU
- Leave the unused pin to a float state

4.5.LED

LED	Function	Description
Green	Indicating connection status	Green LED will light after module connecting to network
Yellow	Indicating data transmission	Yellow LED will blink when module has data transmission

Diagram 4-6 LED definition

4.6.RJ45 interface

Ethernet port of module is 10 M / 100 M adaptive, support AUTO - MDIX, can connect cross-over or direct network cable directly. That is to say, you can use any kind of cable to connect with computer or other network device .

5. Parameters configuration

This chapter mainly introduces how to set the parameters of K7, through which to achieve their own personalized application.

K7 parameter setting methods mainly include setting software setting parameters, K7 built-in web page setting parameters and serial port setting parameters.

User configuration process:

Change the user name and password → set the way to access IP address → serial port parameters → K7 working mode → parameters related to working mode

In order to ensure the normal use of the setup software, the following steps are required:

1. When using setup software to set parameters, it is necessary to ensure that K7 and the computer setting software are in the same LAN.
2. Turn off antivirus software and firewalls on your computer.
3. Close network CARDS unrelated to this test.

5.1. Setup software configure parameters

Open the software setting and click K7(download address:

<https://www.usriot.com/support/downloads/usr-m4-setup-software-v234102.html>), search for all the K7 in the LAN. What you search include current IP, name, MAC address and the vision of K7.

Note: Be sure you have administrative rights and disable any firewalls/anti-virus software when install software.

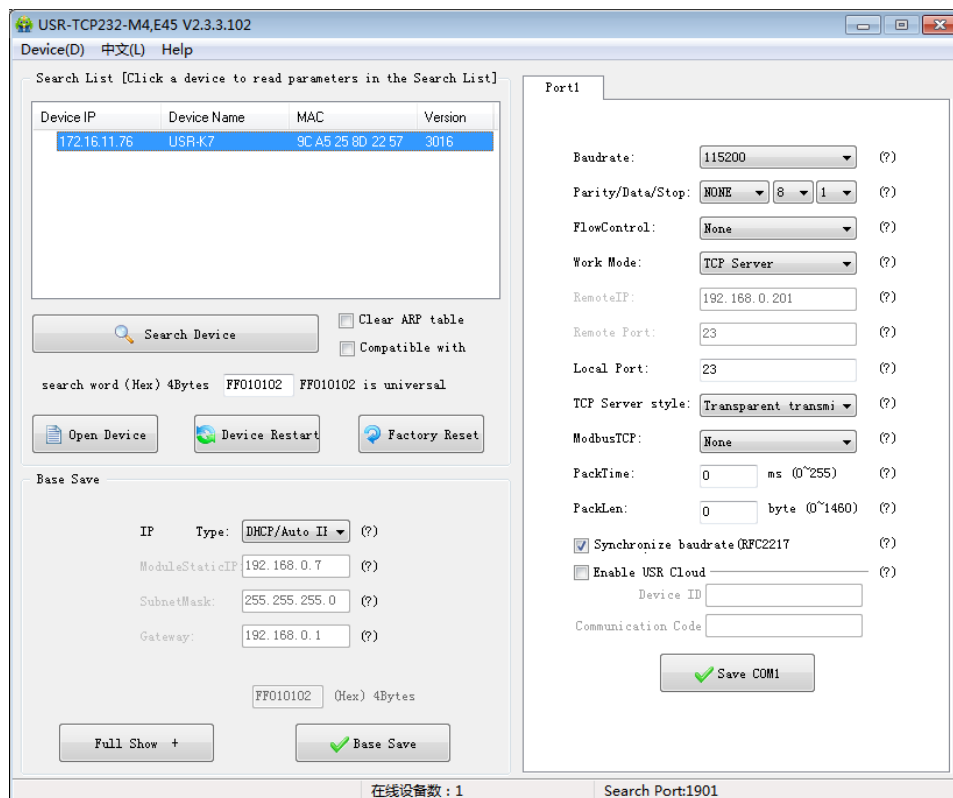

Diagram 5-1 Software setup parameters - search

1. Click on the search content. Firstly check the pass word of K7. If the password is correct, shows information of K7. Otherwise the software will ask you to input, click and confirm. the default user name: admin password: admin (software default user name and password is admin), so the default parameter Settings and there won't pop up Windows.

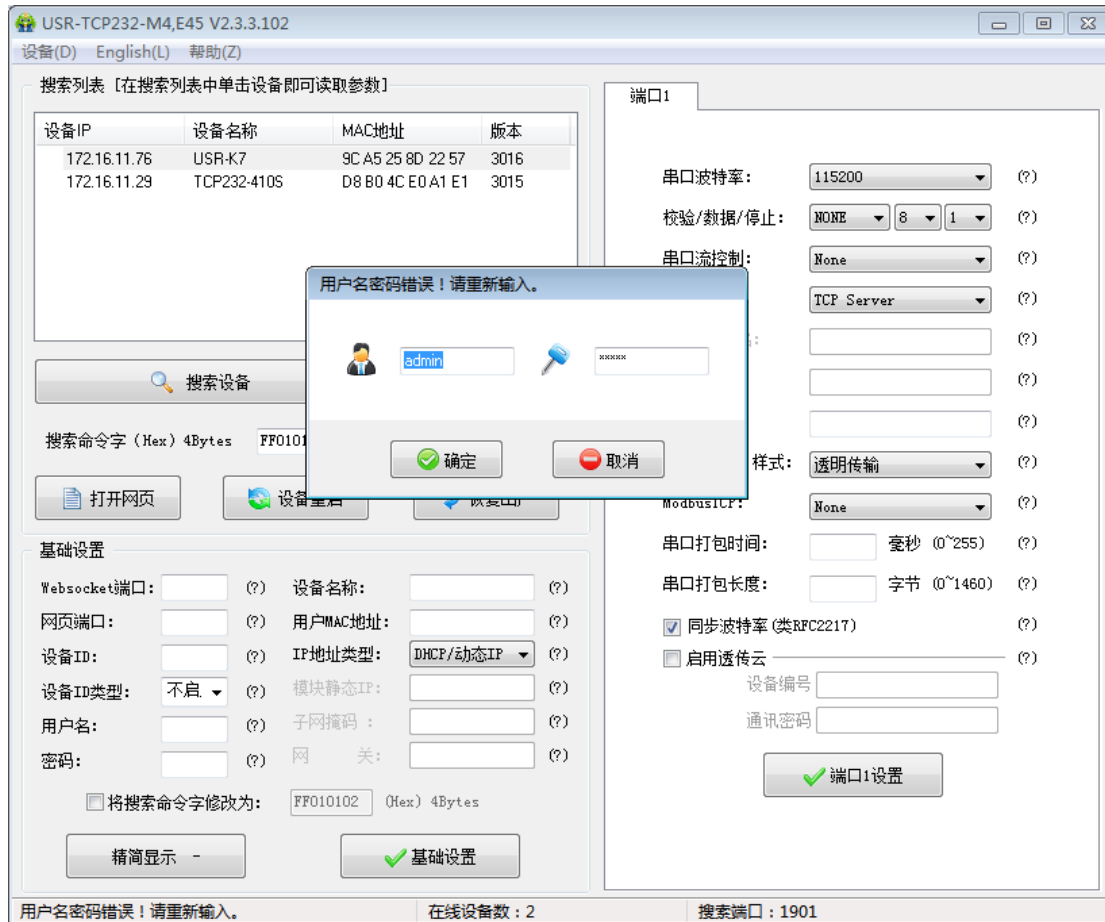

Diagram 5-2 software setup parameters - enter password

2. Basic parameters configuration

Click Full show+ and you will see the all basic parameters needed to set, combined the function introduction and setting the basic parameters. Then you will configure the parameters you need successfully. What you don't need, keep the default is fine.

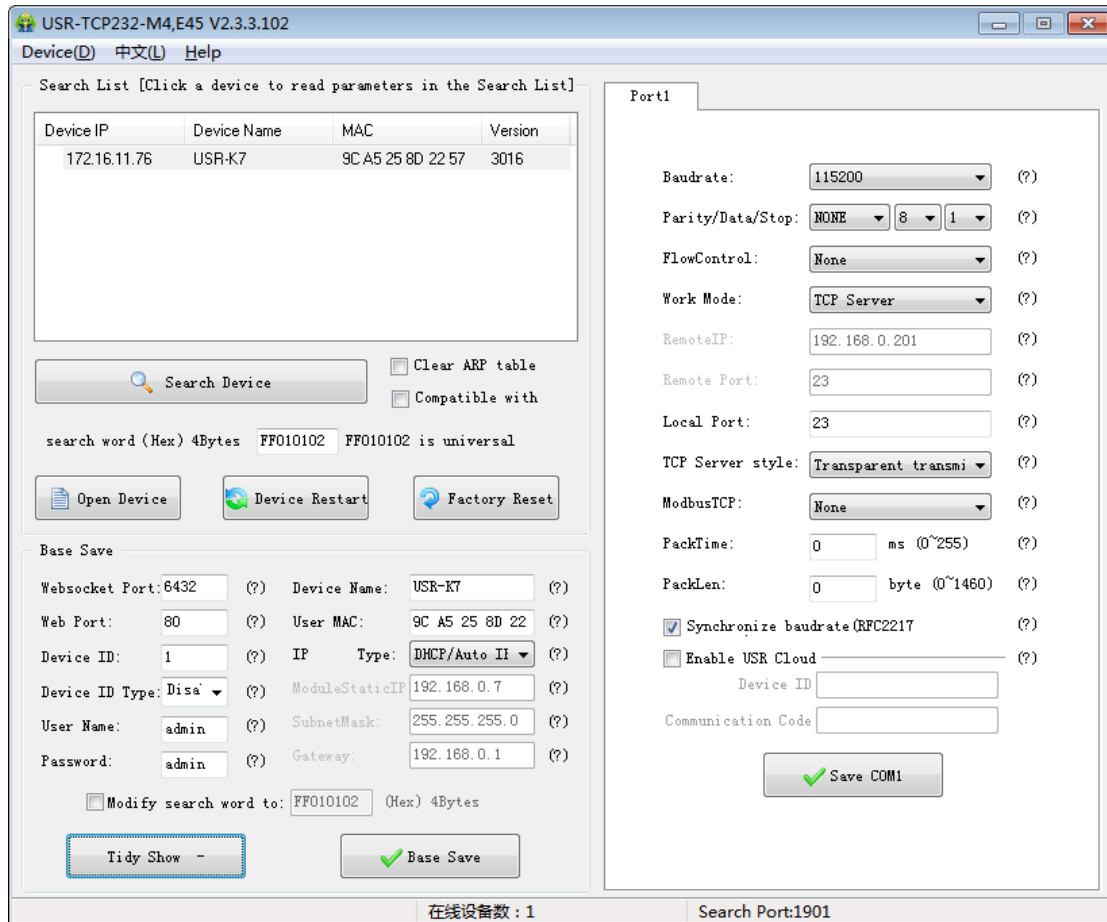

Diagram 5-3software setup parameters - Full show

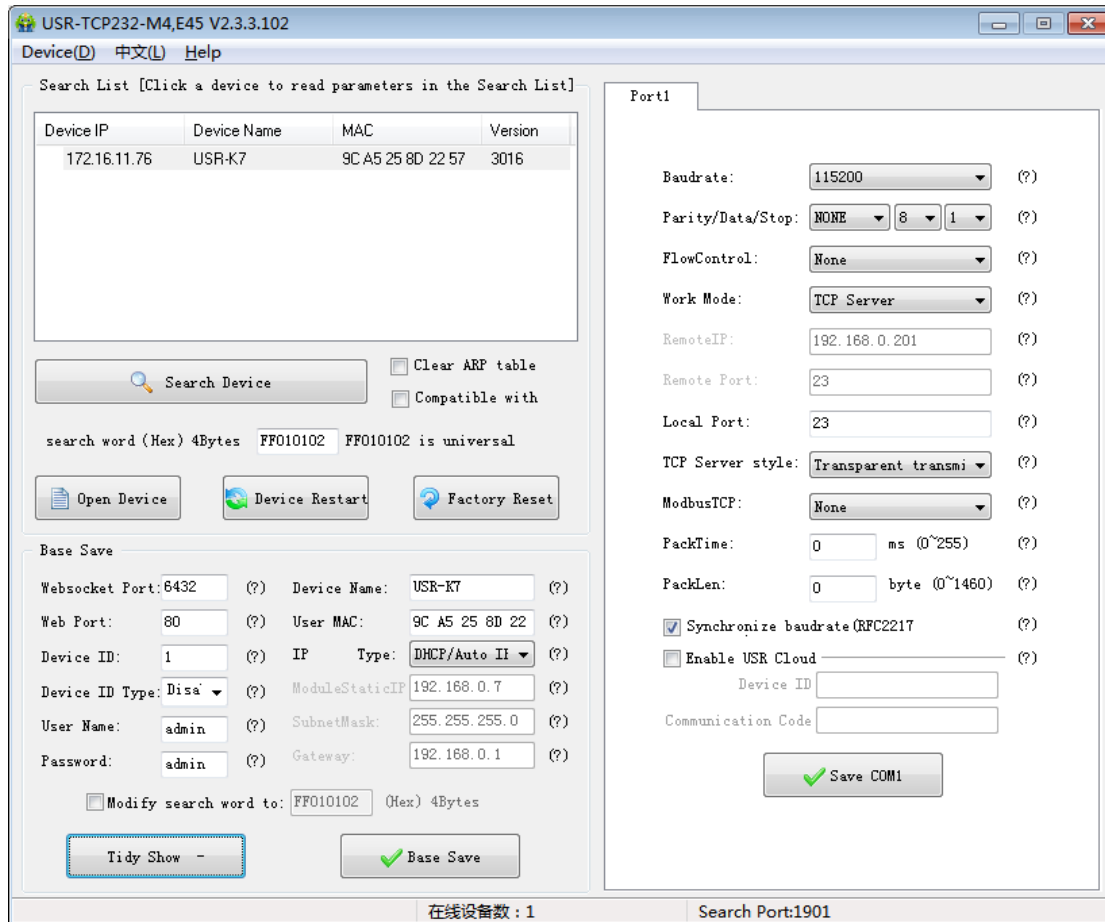

Diagram 5-4 software setup parameters - basic parameters

- ① Websocket port: refer to the function "webpage to serial port" this port same as the port of "webpage to serial port"
- ② Web port: default Web port is 80
- ③ User name: the user name of K7 and the authentication code can prevent other users in the same LAN from modifying K7 parameters .
- ④ Password: same as user name
- ⑤ Device name: can be modified
- ⑥ User MAC: static IP and DHCP/Auto IP
- ⑦ Sub network: default is 255.255.255.0
- ⑧ Gateway: usually is the IP of router. Correct setting you can segment communication, as well as domain name resolution.

3. Port configuration

Click the port you need, change the parameters and click the Save COM after the modification is completed.

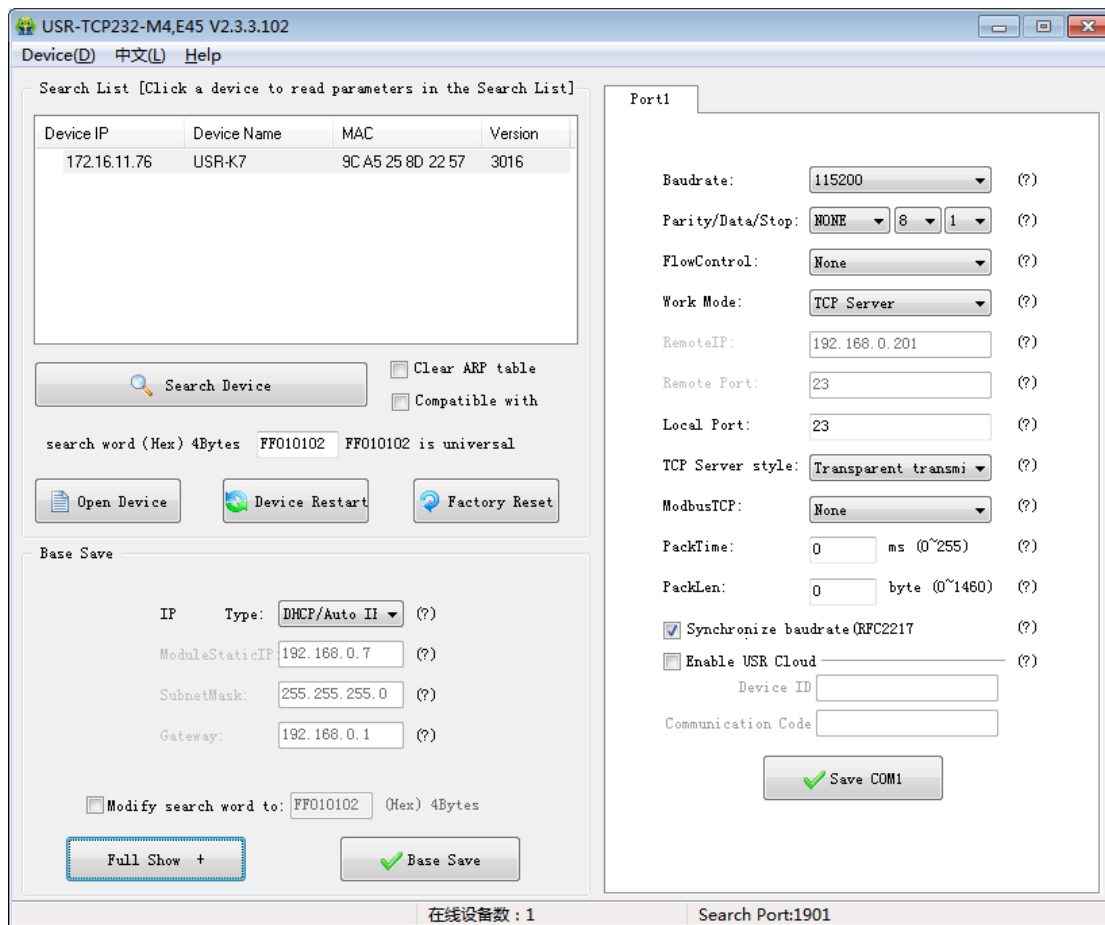

Diagram 5-5 Software setup parameters - port configuration

- ① baud rate: it can be standard baud rate or modified baud rate.
- ② parity/data/stop: serial port parameters
- ③ Flow control:None/RS485/Hardware, choose the hardware to use hardware flow control. None/RS485 means no flow control.
- ④ work mode: TCP Server /TCP Client/ Httpd Client/UDP Client/UDP Server
- ⑤ remote IP: the IP connected to K7 when it work as client. (TCP Client/ Httpd Client/UDP Client)
- ⑥ remote port: the port number at which K7 initiates the connection is recommended to be set to 0 when K7 is the TCP Client, that is, the connection is initiated with a random port number
- ⑦ TCP Server: none
- ⑧ modbus TCP: use it when you use the function Modbus TCP to Modbus RTU
- ⑨ time of serial port : please refer to software of k7
- ⑩ Synchronous baud rate: it is used when the serial port parameters need to be changed during transmission, with the use of virtual serial port software, or refer to the software design manual of K7.

4. Firmware upgrade

The customer can use setup software to upgrade firmware

If the module needs to upgrade to a higher version of the firmware, the user can consult the sales to upgrade the firmware, after getting the updated firmware, click the device, firmware upgrade,

and then upgrade the firmware, when upgrading the firmware, keep the computer only one IP address (the computer and the module is best connected directly, prohibit the computer through WiFi to upgrade the module: firmware).

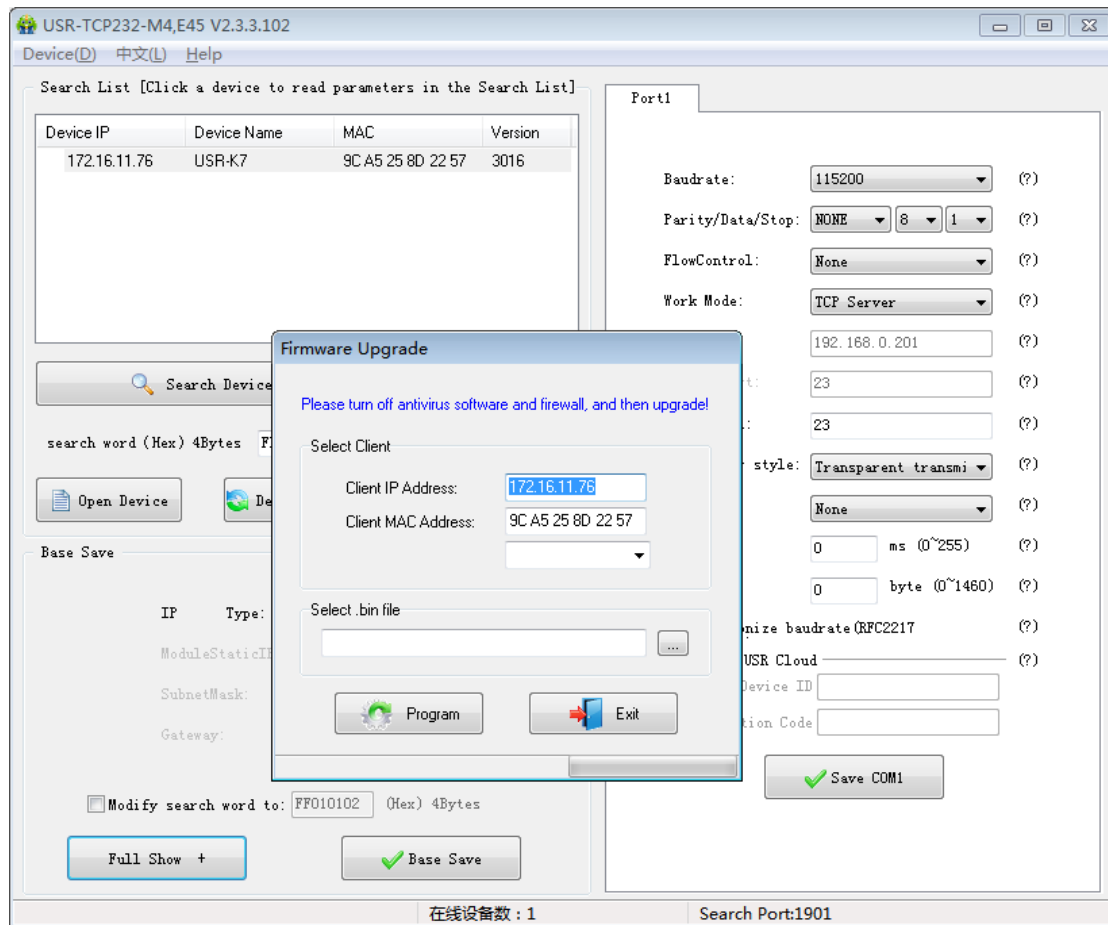

Diagram 5-6 Software setup parameters -upgrade

6. Specific functions

6.1.Modbus RTU to Modbus TCP

As for this function, you can configure it by web page or setup program. Please refer to below example by setup program

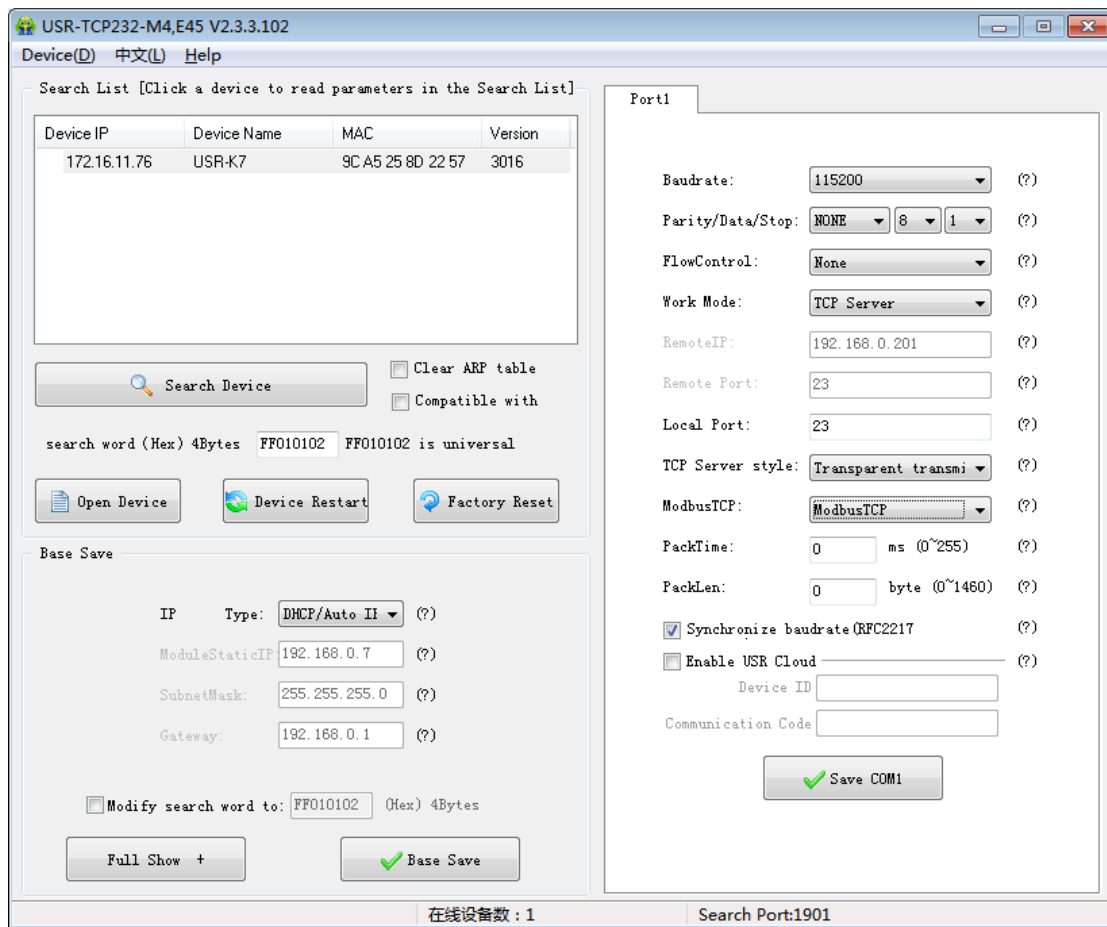

Diagram 6-1 choose Modbus TCP by setup program

Note: There are two options in this place “ Modbus TCP”:

- None, which showed we are using a standard Transparent mode, no protocol conversion .
- Modbus TCP, means we use protocol conversion from Modbus RTU to Modbus TCP.

The function acts as below:

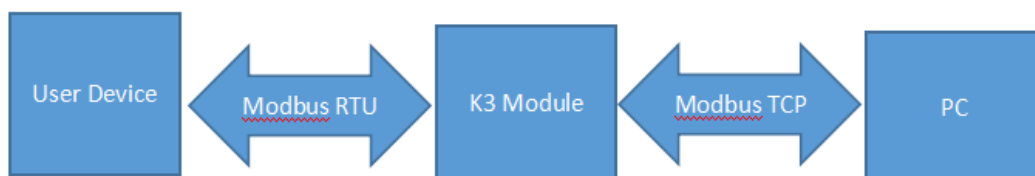

Diagram 6-2 function description for Modbus TCP to modbus RTU

6.2. Heartbeat package

In network transmission mode, the user can choose using K7 send heartbeat package. Heartbeat package can be sent to either a network server or a serial device.

The primary purpose of sending to the network side is to maintain a connection to the server, which only works in TCP Client and UDP Client modes.

In the application where the server sends fixed query instructions to the device, in order to reduce the communication traffic, the user can choose to send heartbeat packets (query instructions) to the serial device in instead of sending query instructions from the server

The firmware of 3010 and later supports the heartbeat package function, which can send heartbeat packets to both the serial port and the network.

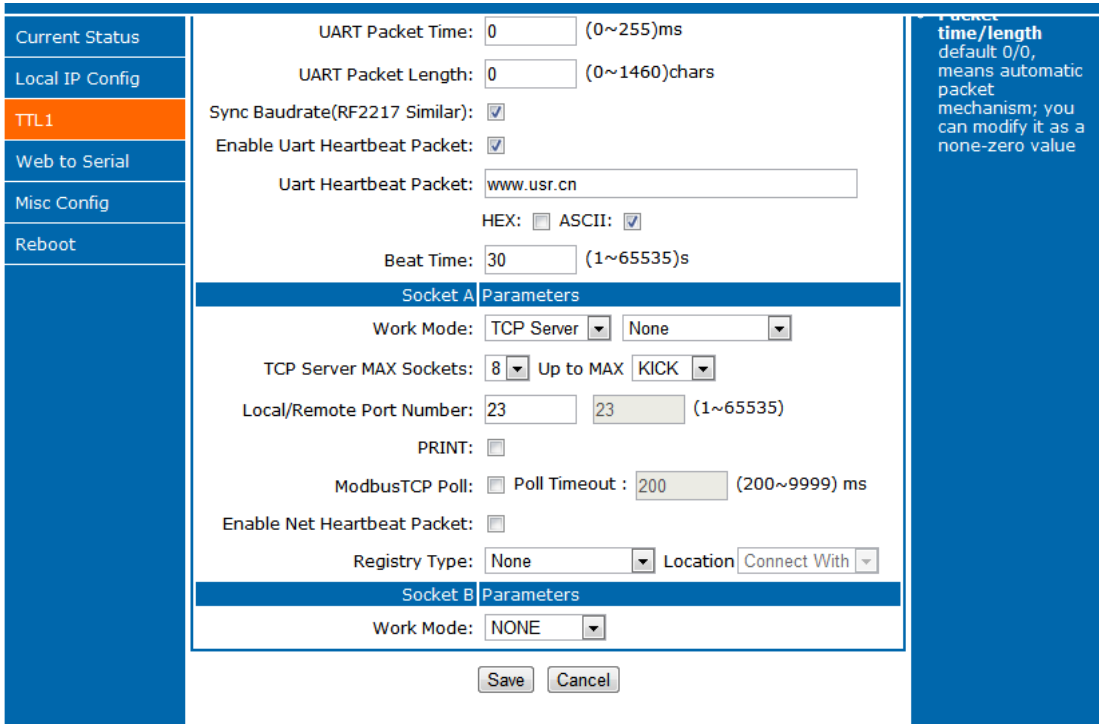

Diagram 6-4 Serial port/network heartbeat package

6.3. Registration package

In transmission mode, users can choose to have the module send the registration package to the server. The registration package is intended to enable the server to identify the device from which the data came, or to use it as a password to obtain authorization for the server's functions.

The registration package can be sent when the module establishes connection with the server, or it can be spliced into the registration package data in front of each package. The data for the registration package can be MAC addresses or customize registry data, and the customize registry sets the content to a maximum of 40 bytes.

Firmware after V3010 supports the registry functionality.

Set up a connection to send a registration package is mainly used to connect to the server which need to register.

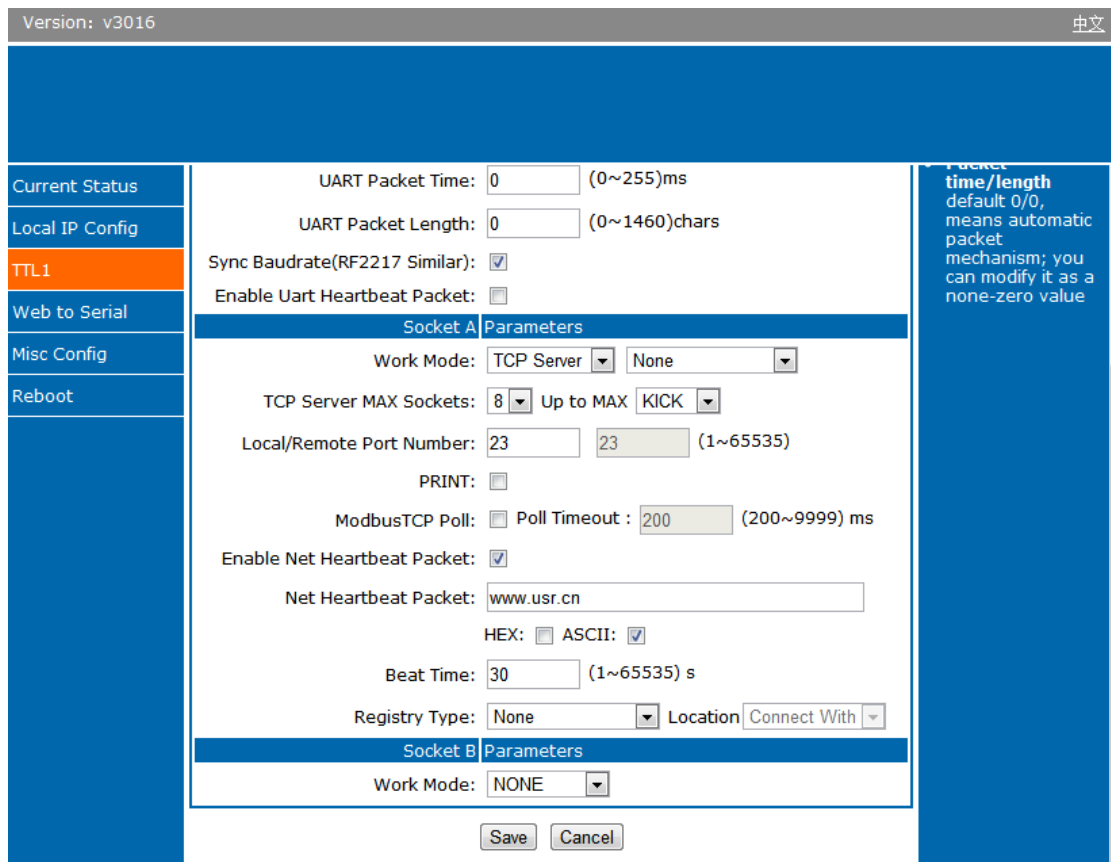

Diagram 6-6 Registration

6.4. Web printing

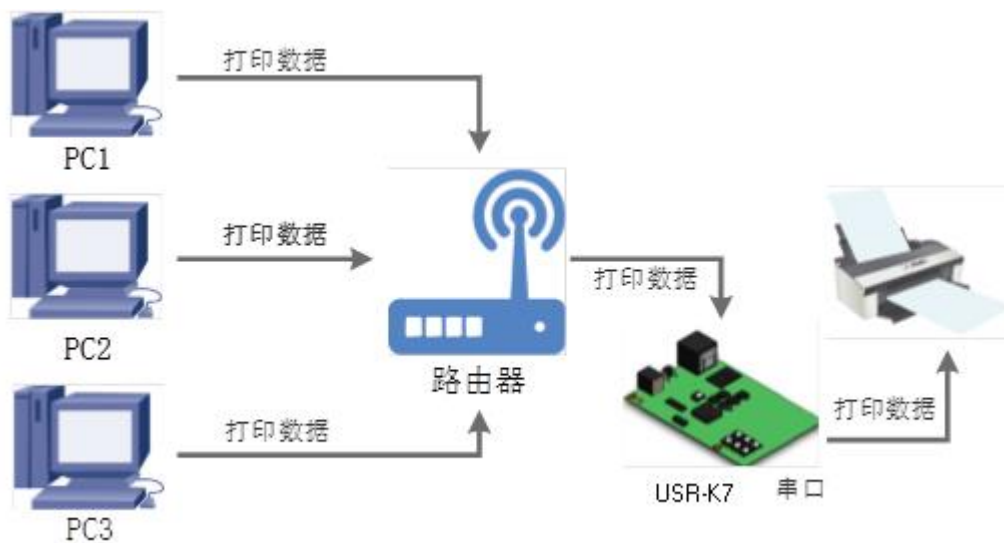

Diagram 6-9 Web printing

6.5. Customize webpage

K7 supports the function that users customize webpage. Users can upgrade their webpage code to K7 by customize webpage and with WebSocket function, they can customize their own communication protocol for transmission, which is more convenient.

If you need to customize webpage, please contact with USR.

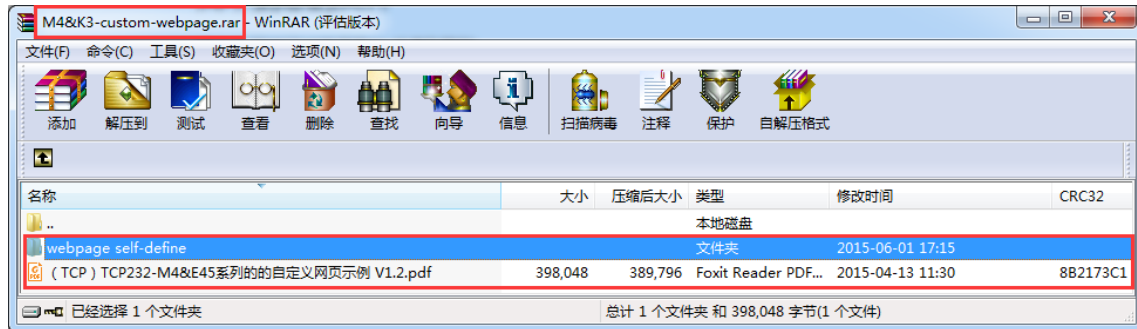

Diagram 6-10 Custom network upgrade package

Pay attention when you customize webpage, the name of final web file is 'fs', select product is M4 and then upgrade.

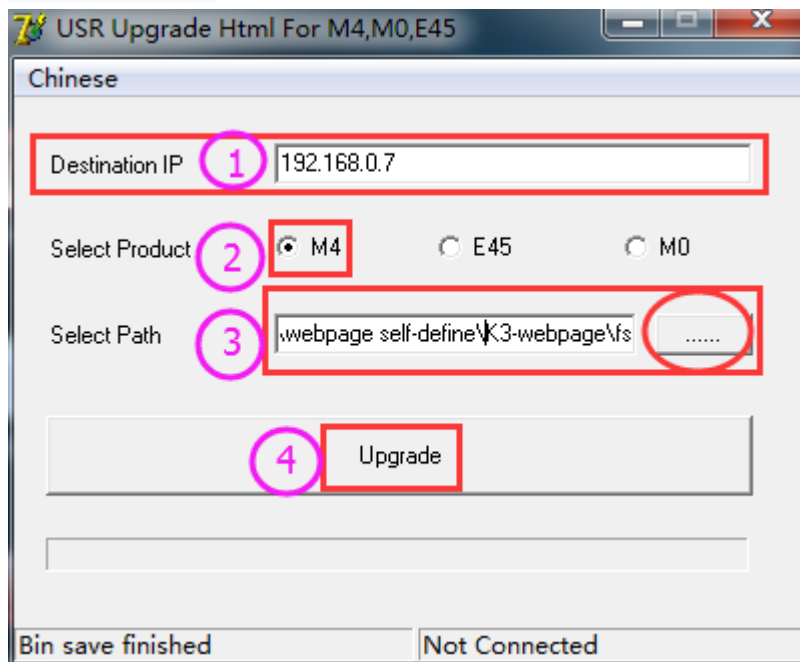

Diagram 6-11 Instructions for customizing web page upgrade software

7. Contact us

Company: Jinan USR IOT Technology Co., Ltd

Address: Floor 11, Building 1, No. 1166 Xinluo Street, Gaoxin Distric, Jinan, Shandong, 250101 China

Tel: 86-531-55507297 86-531-88826739-803

Web: <http://www.usriot.com/>

Support: <http://h.usriot.com/index.php?c=frontTicket&m=sign>

Email: sales@usriot.com

8. Modified history

vision	Modified instruction	Time
V1.0.0	first	2019-05-07